

Elektrometal Energetyka SA



**e<sup>2</sup>TANGO-2000-STP<sup>®</sup>**  
**HV protection unit**  
**(Overcurrent and earth-**  
**fault protection)**



Elektrometal Energetyka SA **FR1 TRANSFORMATOR 110/15 kV TR1**

**eTANGO 3500** Elektrometal Energetyka SA

FR1  
AUTOMATYCZNA  
REG. NAP.  
TRANSFORMATORA

**eTANGO 3500** Elektrometal Energetyka SA

K23  
STEROWANIE  
FALOWY

**eTANGO 2000** Elektrometal Energetyka SA

K23  
STEROWANIE  
FALOWY

**eTANGO 200** Elektrometal Energetyka SA

K41  
AUTOMATYCZNE  
ZMIENIENIE  
NAPRZĄDZENIA

## WE CREATE IDEAS WITH POWER!

The family of the e<sup>2</sup>TANGO-2000-series HV protection relays has been developed by our R&D team consisting of engineers with extensive practical knowledge and many years of experience in the industry. The idea behind creating a high-voltage protection automation platform was to provide clients with operational surety of hardware, software and algorithms.

The e<sup>2</sup>TANGO-50, e<sup>2</sup>TANGO-100, e<sup>2</sup>TANGO-200, e<sup>2</sup>TANGO-400, e<sup>2</sup>TANGO-600, e<sup>2</sup>TANGO-800, e<sup>2</sup>TANGO-1000, e<sup>2</sup>TANGO-1200 protection relays and bay controllers for MV have been installed in thousands of facilities across the country and Europe. The hardware platform is based on the same central unit as for the e<sup>2</sup>TANGO series, of course, with the same configuration of processors, memory cards, inputs/outputs, etc. This makes us absolutely convinced that a few years of trouble-free operation of the e<sup>2</sup>TANGO series hardware gives security for applications in sensitive areas of HV stations and switchgears.

The e<sup>2</sup>TANGO-2000 software was developed on the basis of proven versions for MV controllers, while the algorithms of protections operation were developed in cooperation with the Institute of Power Engineering in Warsaw. Thanks to this, the user can be sure that the applied solutions have been tested over the last few decades and work reliably in many HV facilities in Poland and Europe.

The safety of the HV protection relays' users and operated power facilities was our priority when creating e<sup>2</sup>TANGO-2000. Therefore, in addition to the certainty of the hardware and software side, we have performed a full type testing completed with a certificate confirming the workmanship quality of the HV protection relays series.



Dariusz Rybak  
Chief Designer of the e<sup>2</sup>TANGO series  
Elektrometal Energetyka SA



# APPLICATION OF HV PROTECTIONS

The e<sup>2</sup>TANGO HV protections portfolio constitutes a wide range of protection automation devices, including overcurrent and earth-fault protections, differential protection of transformer, voltage regulator, and line residual current protection. The e<sup>2</sup>TANGO-2000 protection units can be used in bays with the various intended use and operating nature, e.g., in HV line bays or HV/MV transformer bays, but also in facilities of distribution, industrial and other power engineering, which have high-voltage (HV) stations.



## HV/MV transformer bay

- differential protection
- overcurrent protection
- Buchholz protection



## HV line bay

- line differential protection
- automatic reset



## HV choke bay

- differential protection
- overcurrent protection



## HV recipients



## HV station



## HV/MV TRANSFORMER BAY DIAGRAM

A diagram of exemplary HV transformer bay with marked places for installing the e<sup>2</sup>TANGO-2000 and e<sup>2</sup>TANGO-200 type protection automation is presented below.

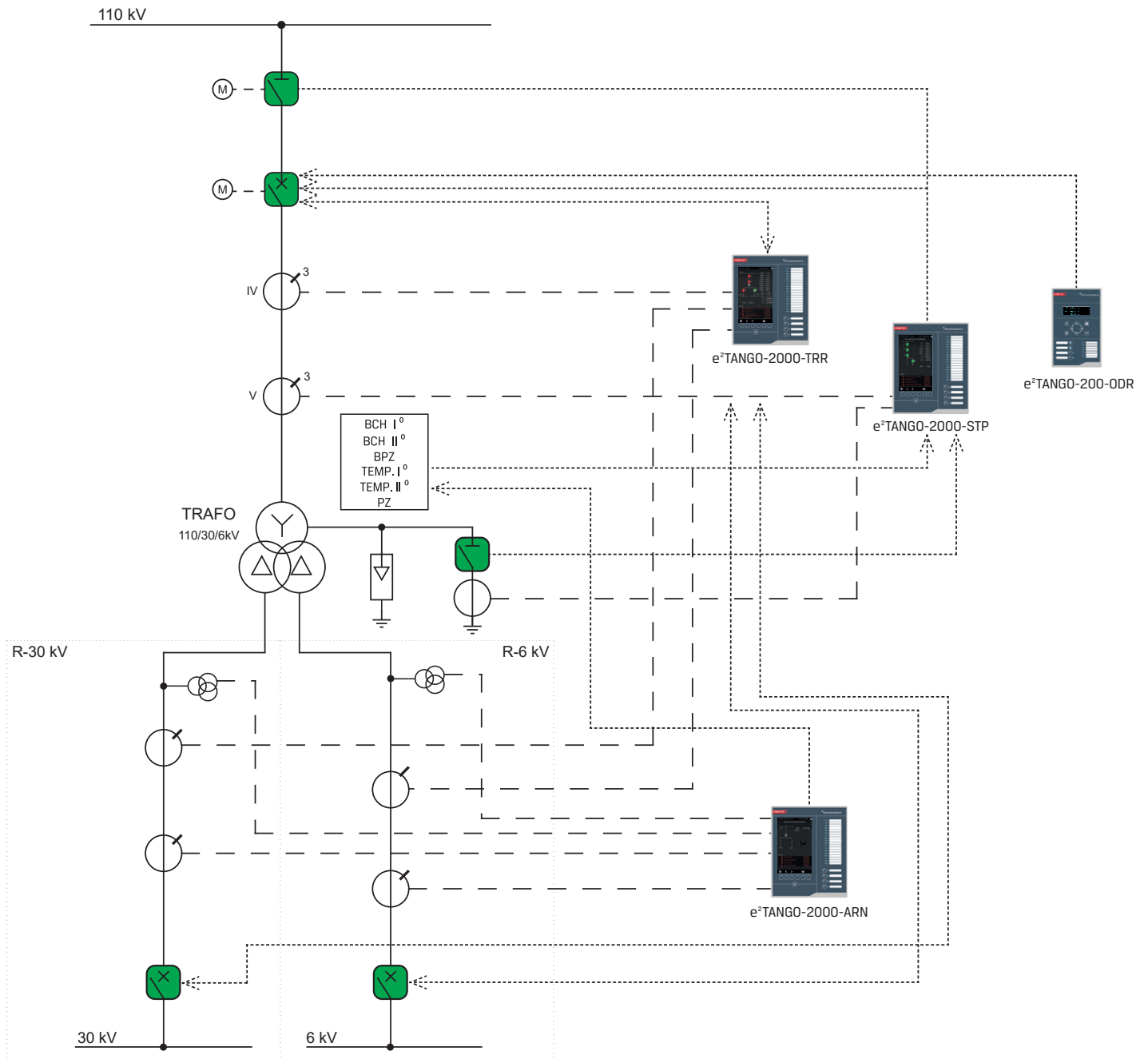

A comprehensive solution for the HV transformer bay, which includes all protection automation elements based on the e<sup>2</sup>TANGO platform, is demonstrated. The transformer differential protection (TRR), bay controller (STP), and voltage regulator (ARN) are constructed on the e<sup>2</sup>TANGO-2000 base; while, autonomous protections, e.g., -ODR, are designed based on the e<sup>2</sup>TANGO-200 protection with capacity accumulator.

# ADVANTAGES OF HV PROTECTIONS



## spinning reserve

restoring the bay to work after a failure within several minutes, possibility to restore all bay data, e.g.: settings, logic, events



## remote service access

remote and local readout of diagnostic data with the possibility of sending it to the manufacturer's service



## tested algorithms

protection algorithms developed in cooperation with the Institute of Power Engineering



## verified hardware base

basing on proven hardware and software of e<sup>2</sup>TANGO MV controllers

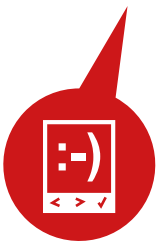
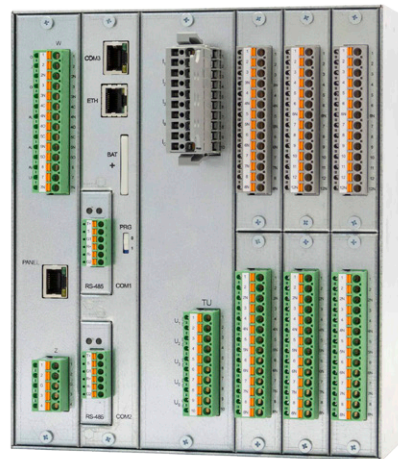

## intuitive interface

legible menu layout, illustrative captions and markings

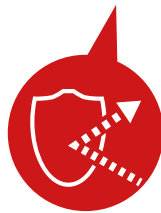

## high interference resistance

up to 100% higher than required by the standard

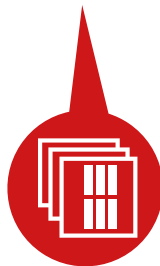

## wide range of hardware configurations

6-, 10-, 14-slot units are available with surface, flush, and mixed installation option

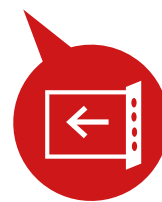

## expansion cards diversity

modular design based on expansion and communication cards, up to 168 inputs and up to 39 outputs

Intuitive and easy-to-use e<sup>2</sup>TANGO HV protection units are equipped with a fully configurable, clear screen and extensive configuration, registration, and measurement functions. The legibility of indications and signalling, easy access to documentation and instructions, easy verification of logic operation, and graphical verification of protections characteristics or remote service access definitely improve daily work with the device.

**preview of the diagram and logic current status**  
logic and synoptic diagrams

**complete operating manual**  
quick access to the associated chapters of the technical documentation

**legible menu**  
pictorialness of captions and markings

**graphic presentation of parameters**  
phasors, harmonics content

**fully configurable graphic interface**  
up to five configurable screens, rich widget base

**can be operated without instructions**  
quick-access help

**2.2.5 TRP WRN/AL signalling**

Parameter	Description	Range
TRP	TRP signalis	Pole 11 SZR   Subset 1
WRN	WRN signalis	
AL Autoclearing	Autoclearing	
Clear op. w/lat	Clear latcher operations	

**Events:**

1. **CIRCUIT BREAKER SPN**
2. **e2TANGO RESTART**
3. **NO SUPPLY VOLTAGE**
4. **CIRCUIT BREAKER SPN**

**Menu:**

- Signaling reason TRP/WRN/AL
- Events
- Recorders
- BLCK/UNBLCK automatics
- Configuration
- Single-line diagram
- Logic
- Switchgear diagram
- Input/output states
- User labels
- Measurements
- Tests
- Login
- Logout
- USB
- Language
- Services menu

## DESIGN

The e<sup>2</sup>TANGO-series HV protections consist of two elements: operator panel and central unit. The central unit is made based on expansion cards and comes in three housing versions: J6 (6 cards), J10 (10 cards) and J14 (14 cards) - depending on the complexity of the switchboard bay layout and user's needs. The e<sup>2</sup>TANGO-2000 operator panel has a 7-inch, high-resolution colour screen.

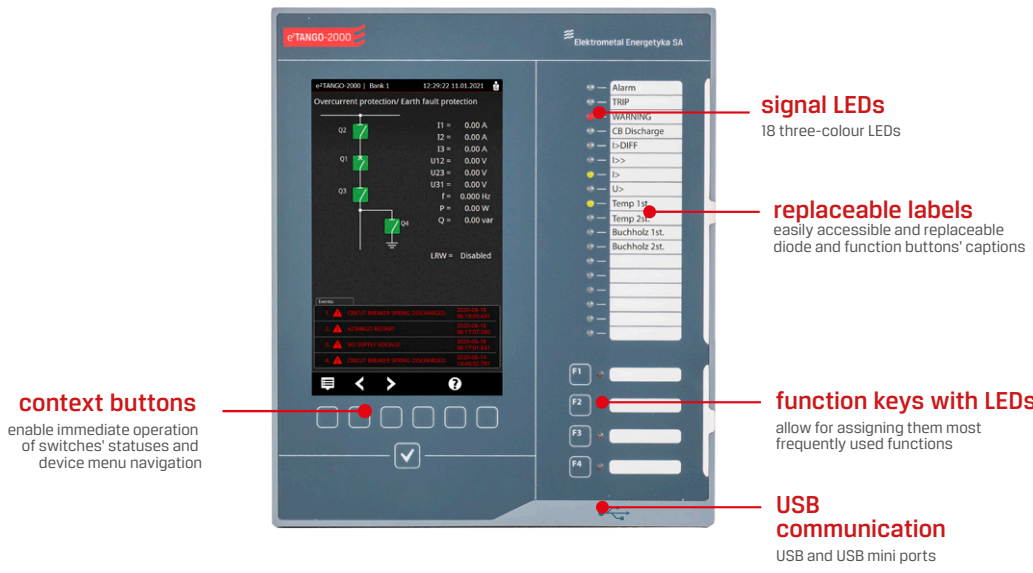

**context buttons**  
enable immediate operation of switches' statuses and device menu navigation

**signal LEDs**  
18 three-colour LEDs

**replaceable labels**  
easily accessible and replaceable diode and function buttons' captions

**function keys with LEDs**  
allow for assigning them most frequently used functions

**USB communication**  
USB and USB mini ports

INTERFACE AND OPERATION	
Display	7"
Display resolution	800x480 px
Colour display	•
Touch screen	0
Context buttons (quantity)	-
Control buttons (v)	0
Programmable function keys with LEDs	4
LED	18
Virtual LED (on LCD)	0
Virtual function keys (on LCD)	0
Replaceable labels	•
DESIGN AND EQUIPMENT	
Panel dimensions (external - HxWxD)	252x215x41,5
Mounting opening dimensions in flush version	228x191
External central unit	•
J6 unit	0
• 6 slots	
• dimensions: 222x187x103 (HxWxD))	
J10 unit	•
• 10 slots	
• dimensions: 222x234x103 (HxWxD)	

J14 unit	0
• 14 slots	
• dimensions: 222x281x103 (HxWxD)	
STANDARD EQUIPMENT**	
number of binary inputs (max.*)	28 (168)
number of binary outputs (max.*)	23 (39)
Max. number of switches	12
Analogue inputs 0-10 V (max.)**	0 (4)
Analogue outputs 4-20 mA (max.)**	0 (4)
Analogue output 0-10 V (max.)**	0 (4)
Temperature inputs (max.)**	0 (12)
Current measuring card for differential protection	0 (2 dla TRR)
OTHER	
Widgets	•
Number of configurable screens	5
Logic preview on display	•

•/o - standard/option  
\* - for the largest unit available and with all slots occupied with one type of card  
\*\* - the required number of expansion cards

## PROTECTION FUNCTIONS

23/26	Temperature protection (PT100 sensor)
23/26	Temperature measurement from busbars with optical fiber sensors
23/26/62	Temperature protection (binary)
27/27P	Undervoltage
46	Phase balance or reverse sequence current protection
49	Thermal protection
50/50N/50Ns/50G	Overcurrent / ground overcurrent protection
50HS/SOTF	Switch on to fault protection
51/51N/51Ns/51G	Time overcurrent / ground time overcurrent protection
51N/59N	Ground time overcurrent with voltage interlock

59/59P/59_1/59_2	Overvoltage
59N	Ground overvoltage
62	External binary protection
67/67N/67Ns/67G	Directional overcurrent / ground directional overcurrent protection
74TCS	Trip, close coil supervision
80	Flux-gas
810	Over-frequency protection
81R	Rate of change of frequency
81U	Under-frequency protection
CAM	Preview from the cameras on the panel screen
S&H	Safety and health notice



## AUTOMATION

- (25) Synchronism-Check
- (50BF) Breaker failure protection
- (79) Auto reclose
- (81U/81O) Automatic load shedding
- (83) Automatic transfer switch

## EXPANSION CARDS

### PRIMARY CARDS

- power supply or power supply with reinforced contacts (connection ability up to 10 A DC)
- processor



### MEASURING CARDS

- standard (5I+4U)
- synchrocheck (4I+5U)

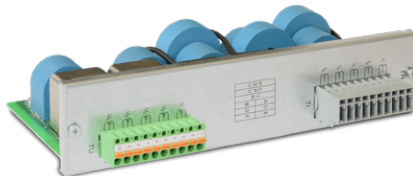

### FUNCTION CARDS

- 8 binary inputs
- 12 binary inputs
- 8 relay outputs
- 4 relay outputs with reinforced contacts (connection ability up to 10 A DC)



### ANALOGUE CARDS

- 4 analogue inputs 0-10 V
- 4 analogue inputs 4-20 mA
- 4 analogue outputs 0-10 V
- 4 analogue outputs 4-20 mA



### TEMPERATURE CARDS

- 6 temperature inputs PT100
- 6 temperature inputs PT1000



## PORTS AND COMMUNICATION PROTOCOLS

- Ethernet
- Single-mode optical fibre - OPTOSM
- Multi-mode optical fibre - OPTOMM
- Plastic optical fibre - OPTOP
- RS485
- CANbus 2x
- USB 2.0
- WiFi\*

- Modbus RTU/TCP
- IEC 60870-5-103
- DNP 3.0
- Profibus
- CANbus/PPM 2
- IEC 61850



\*after agreement with the manufacturer

## RECORDERS

- event recorder, 1000 events
- interference recorder up to 160 s sampling frequency 1.6-3.2 kHz
- criterion recorder for TRR 250 ms
- recording of instantaneous values, TrueRMS
- phasor

# DIMENSIONS

## e<sup>2</sup>TANGO-2000

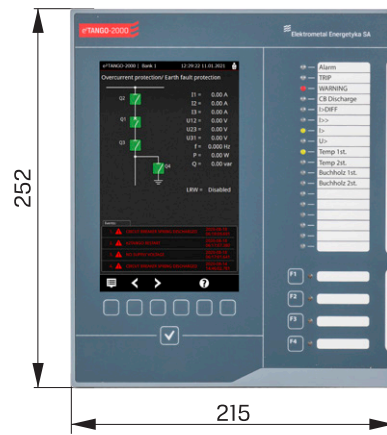

J6

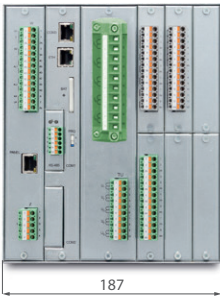

J10

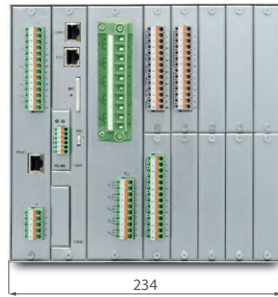

J14

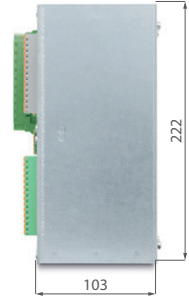
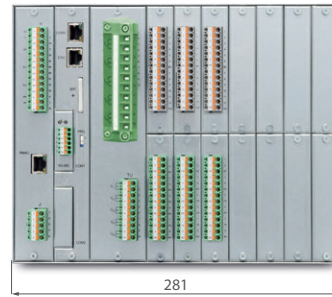

# INSTALLATION METHODS

flush installation

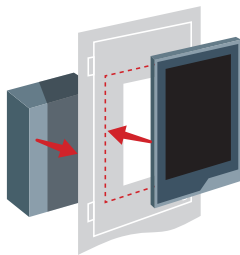

surface installation

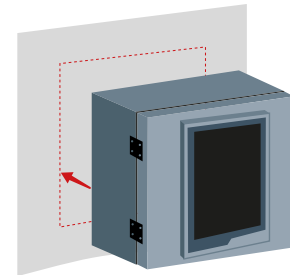
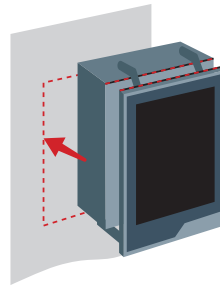

mixed installation

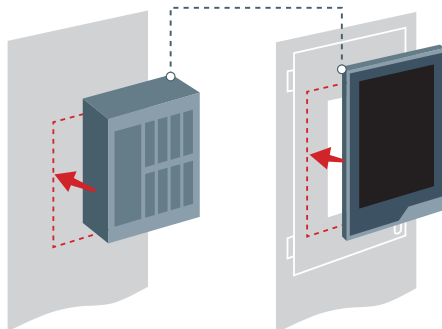

installation in a rack cabinet

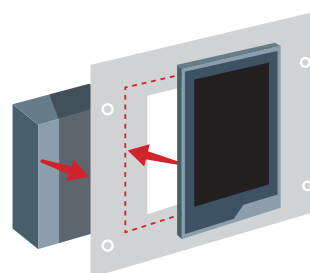

## TECHNICAL PARAMETERS

<b>POWER SUPPLY WITH AUXILIARY VOLTAGE</b>	
DC voltage	110 V, 220 V (80-300 V DC)
AC voltage	230 V (88-265 V AC)
Optional	24-48 V (19-58 V AC/DC)
Max. power consumption (panel and unit)	30 W (VA)
<b>CURRENT MEASUREMENT CIRCUITS</b>	
Rated current	1 A or 5 A
Rated frequency	50 Hz
Phase current measurement range	0.05-150 A
IO current measurement range	0.1-100 A
<b>VOLTAGE MEASUREMENT CIRCUITS</b>	
Rated voltage	57,7/100 V
Rated frequency	50 Hz
Voltage measurement range	3-120 V
<b>MEASUREMENT ACCURACY</b>	
I1, I2, I3 (0.1-150 A)	1%
U1, U2, U3, U0 (5-120 V)	1%
IO (0.1-100 A)	1%
P, Q, EC, EB (U>5 V, 0.1 A<I<10 A)	1%
f (U>5V)	10 mHz
$\varphi$ 1, $\varphi$ 2, $\varphi$ 3, $\varphi$ 0 (U>5 V, 0.1 A<I<10 A)	1°
<b>PROTECTIONS PARAMETERS</b>	
Overcurrent protections operate time	typically 35 ms
Reset ratio of overload protections	Configurable
Reset ratio of underload protections	Configurable
<b>PARAMETERS OF W1, W2, W3 BINARY OUTPUTS (BREAKER CONTROL)</b>	
Voltage on open contacts	250 V AC, 440 V DC
Circuit activation at 220 V DC	5.0 A
Circuit deactivation at 220 V DC (L/R = 40 ms)	0.3 A 5 A (for PSUHI card)
Circuit deactivation at 220 V AC (cos $\varphi$ = 0.4)	2.0 A
<b>PARAMETERS OF BINARY OUTPUTS (OTHER)</b>	
Voltage on open contacts	250 V AC, 440 V DC
Permanent load	5.0 A
Circuit deactivation at 220 V DC (L/R = 40 ms)	0.1 A 5 A (for OUTHI card)
Circuit deactivation at 220 V AC (cos $\varphi$ = 0.4)	2.0 A
<b>PARAMETERS OF BINARY INPUTS</b>	
Rated voltage	110/230 V AC/DC
Optional	24-48 V AC/DC
Other on request	
Maximum current consumption at 220 V DC; 230 V AC	2 mA; 15 mA
<b>ENVIRONMENTAL CONDITIONS</b>	
Operating temperature	-10°C to +55°C
Storage temperature	-25°C to +70°C
<b>RELATIVE HUMIDITY</b>	
	5% to 95%, without water vapour condensation
Vibrations and mechanical impacts	Class 1 acc. to IEC 60255-21
Electromagnetic interferences	Class B acc. to IEC 60255-26
<b>SAFETY</b>	
Insulation electric strength	2 kV/50 Hz/60 s acc. to IEC 60255-27
<b>DIMENSIONS</b>	
Weight (central unit/operator panel)	5 kg/1 kg
Central unit dimensions (WxDxH mm)	222x103x187/234/281
Central unit protection class	IP 3X/IP 4X (option)
Panel protection class (front plate side)	IP 4X/IP 54 (option)

# e<sup>2</sup>TANGO-STUDIO SOFTWARE

The e<sup>2</sup>TANGO-Studio is an engineering program dedicated to the e<sup>2</sup>TANGO bay controller and, at the same time, a configuration tool for the panel. The programme has been developed and equipped with a rich set of functionalities, which, combined with a clear visual configuration of widgets, becomes excellent support in everyday work, enabling the creation of projects for many devices, panels, switchboards, or stations.



**advanced designing**  
possibility of preparing the devices' configuration for the whole switchboard on the PC and its distribution using USB

**user elements**  
defining customised graphic elements of the synoptic diagram



**quick configuration assistant**  
facilitating the first use of the programme and support during regular work



**on-line preview**  
live preview of I/O statuses, measurements; real preview of the image displayed on the LCD screen

**displaying compliance**  
preview of the actual view of the panel screen

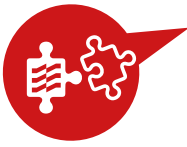

**possible further expansion**  
using plug-ins

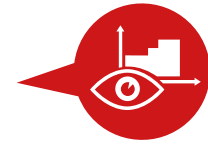

**visual characteristics' shaping**  
graphical and standard configuration of protections' settings

**simple verification of settings and selectivity**  
presentation of the whole overcurrent protections' family presentation on one chart

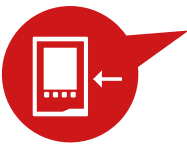

**full statuses' view**  
access to all internal statuses of the device and protections

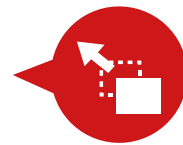

**instant user screen designing**  
placing elements supported by drag&drop method

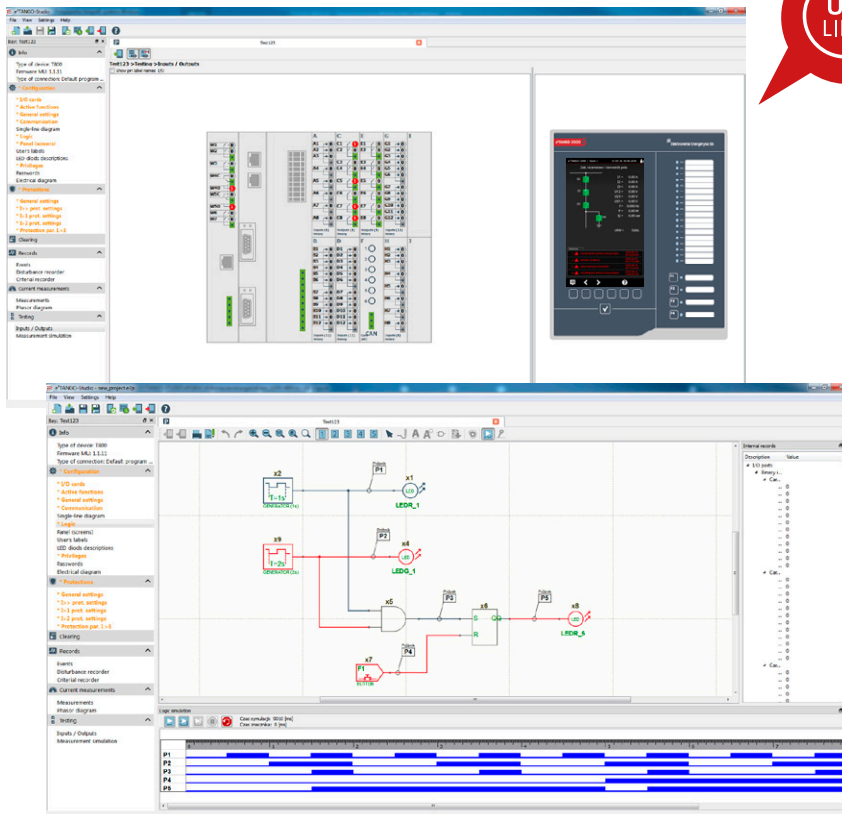

**logic simulator**  
possibility of full simulation of logic without connecting to the device

**logic legibility**  
possibility of dividing the logic into blocks and sheets

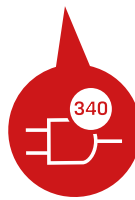

**operation of extended logical dependencies**  
up to 340 logical gates/functions

## ADVANCED LOGIC EDITOR AND SIMULATOR

The e<sup>2</sup>TANGO-Studio features an advanced and extended logic editor that allows for simulating the logic circuit, also visible from the panel, without connecting the device. It allows previewing logical statuses while working with the device, which facilitates project preparation, as well as commissioning and servicing of switching stations. It gives the possibility to design non-standard logics dedicated to the requirements of the client's infrastructure.

## STANDARISATION

PN-EN 60255-1	Measuring relays and protection equipment. Part 1: Common requirements
PN-EN 60255-26	Measuring relays and protection equipment. Part 26: Electromagnetic compatibility requirements
PN-EN 60255-27	Measuring relays and protection equipment. Part 27: Product safety requirements

## CERTIFICATES AND AWARDS



**IEEn Certificate of Compliance**  
No. 005/2019

for the e<sup>2</sup>TANGO-2000 HV  
protection units



**Gold medal**  
ENERGETAB 2015 trade fair



**Minister of Energy Cup**  
ENERGETAB 2018 trade fair



**Mazovian Quality Award**

## ELEKTROMETAL ENERGETYKA SA QUALITY

Integrated Management System is implemented in the company, based on the following standards:

- PN-EN ISO 9001 Quality management systems
- PN-EN ISO 14001 Environmental management systems
- PN-EN ISO 45001 Occupational health and safety management systems

# ORDER FORM

To order the e<sup>2</sup>TANGO-2000 protections, please fill in this part of the form according to the INSTRUCTIONS FOR FILLING IN THE FORM on the next page.

## STEP 1

① panel version	<input checked="" type="checkbox"/> 2000-STP
② central unit version	<input checked="" type="checkbox"/> J6 <input type="checkbox"/> J10 <input type="checkbox"/> J14 <input type="checkbox"/> J6H <sup>1)</sup> <input type="checkbox"/> J10H <sup>1)</sup> <input type="checkbox"/> J14H <sup>1)</sup>
③ TR measuring card version	<input type="checkbox"/> TR (standard, 5I+4U) <input checked="" type="checkbox"/> TRS (4I+5U)
④ measuring card parameters	<input checked="" type="checkbox"/> 5 A <input type="checkbox"/> 1 A
⑤ power supply voltage	<input checked="" type="checkbox"/> UNI (110/230 V AC/DC) <input type="checkbox"/> 24V (24/48 V AC/DC) <input type="checkbox"/> others
Ethernet communication port (standard on each central unit)	
⑥ COM1	<input checked="" type="checkbox"/> x-none <input type="checkbox"/> RS485 <input type="checkbox"/> CANx2 <input type="checkbox"/> OPTOMM <input type="checkbox"/> OPTOP <input type="checkbox"/> Profibus <input type="checkbox"/> others
⑦ COM2	<input checked="" type="checkbox"/> x-none <input type="checkbox"/> RS485 <input type="checkbox"/> CANx2 <input type="checkbox"/> OPTOMM <input type="checkbox"/> OPTOP <input type="checkbox"/> Profibus <input type="checkbox"/> others
⑧ installation method	<input checked="" type="checkbox"/> Z-flush <input type="checkbox"/> N1 - surface ver. 1 <input type="checkbox"/> N3 - surface ver. 3 <input type="checkbox"/> M - Mixed <input type="checkbox"/> ZR - flush in rack cabinet
⑨ panel-unit cable length	<input checked="" type="checkbox"/> S-1 m <input type="checkbox"/> L-2 m <input type="checkbox"/> other
⑩ IP protection class	<input checked="" type="checkbox"/> IP 4X <input type="checkbox"/> IP 54 <sup>2)</sup>
⑪ communication IEC 61850	<input checked="" type="checkbox"/> EX-none <input type="checkbox"/> O-ETH fibre optic <input type="checkbox"/> O2-ETH fibre optic with PRP <input type="checkbox"/> O2G-O2+GOOSE <input type="checkbox"/> E2-electric
	<input type="checkbox"/> E-ETH electric <input type="checkbox"/> EG-ETH electric+GOOSE <input type="checkbox"/> OG-ETH fibre optic +GOOSE <input type="checkbox"/> E2G-electric +GOOSE
⑫ language version	<input type="checkbox"/> PL <input checked="" type="checkbox"/> EN <input type="checkbox"/> other (in agreement with manufacturer)

1) reinforced W1, W2, W3 outputs

2) protection class IP 54 only available in version with flush and mixed installation

## STEP 2

Card name	Kod	Slot													
		A	B	C	D	E	F	G	H	I	J	K	L	M	N
CPU processor card	-	standard in every device													
PSU power supply card - 7 relay outputs	-	standard in every device													
Ethernet communication port	-	standard in every device													
8 binary inputs	8IN	<input checked="" type="checkbox"/>	<input type="checkbox"/>	<input type="checkbox"/>	<input type="checkbox"/>	<input type="checkbox"/>	<input type="checkbox"/>	<input type="checkbox"/>	<input type="checkbox"/>	<input type="checkbox"/>	<input type="checkbox"/>	<input type="checkbox"/>	<input type="checkbox"/>	<input type="checkbox"/>	<input type="checkbox"/>
12 binary inputs	12IN	<input type="checkbox"/>	<input type="checkbox"/>	<input checked="" type="checkbox"/>	<input type="checkbox"/>	<input type="checkbox"/>	<input type="checkbox"/>	<input type="checkbox"/>	<input type="checkbox"/>	<input type="checkbox"/>	<input type="checkbox"/>	<input type="checkbox"/>	<input type="checkbox"/>	<input type="checkbox"/>	<input type="checkbox"/>
8 binary inputs 24-48 V*	8IN24	<input type="checkbox"/>	<input type="checkbox"/>	<input type="checkbox"/>	<input type="checkbox"/>	<input type="checkbox"/>	<input type="checkbox"/>	<input type="checkbox"/>	<input type="checkbox"/>	<input type="checkbox"/>	<input type="checkbox"/>	<input type="checkbox"/>	<input type="checkbox"/>	<input type="checkbox"/>	<input type="checkbox"/>
12 binary inputs 24-48 V*	12IN24	<input type="checkbox"/>	<input type="checkbox"/>	<input type="checkbox"/>	<input type="checkbox"/>	<input type="checkbox"/>	<input type="checkbox"/>	<input type="checkbox"/>	<input type="checkbox"/>	<input type="checkbox"/>	<input type="checkbox"/>	<input type="checkbox"/>	<input type="checkbox"/>	<input type="checkbox"/>	<input type="checkbox"/>
8 relay outputs	8OUT	<input type="checkbox"/>	<input checked="" type="checkbox"/>	<input type="checkbox"/>	<input type="checkbox"/>	<input type="checkbox"/>	<input type="checkbox"/>	<input type="checkbox"/>	<input type="checkbox"/>	<input type="checkbox"/>	<input type="checkbox"/>	<input type="checkbox"/>	<input type="checkbox"/>	<input type="checkbox"/>	<input type="checkbox"/>
4 relay outputs, reinforced	4OUTH	<input type="checkbox"/>	<input type="checkbox"/>	<input type="checkbox"/>	<input type="checkbox"/>	<input type="checkbox"/>	<input type="checkbox"/>	<input type="checkbox"/>	<input type="checkbox"/>	<input type="checkbox"/>	<input type="checkbox"/>	<input type="checkbox"/>	<input type="checkbox"/>	<input type="checkbox"/>	<input type="checkbox"/>
4 analogue inputs 0-10 V	AI10	<input type="checkbox"/>	<input type="checkbox"/>	<input type="checkbox"/>	<input type="checkbox"/>	<input type="checkbox"/>	<input type="checkbox"/>	<input type="checkbox"/>	<input type="checkbox"/>	<input type="checkbox"/>	<input type="checkbox"/>	<input type="checkbox"/>	<input type="checkbox"/>	<input type="checkbox"/>	<input type="checkbox"/>
4 analogue inputs 4-20 mA	AI20	<input type="checkbox"/>	<input type="checkbox"/>	<input type="checkbox"/>	<input type="checkbox"/>	<input type="checkbox"/>	<input type="checkbox"/>	<input type="checkbox"/>	<input type="checkbox"/>	<input type="checkbox"/>	<input type="checkbox"/>	<input type="checkbox"/>	<input type="checkbox"/>	<input type="checkbox"/>	<input type="checkbox"/>
4 analogue outputs 0-10 V	AO10	<input type="checkbox"/>	<input type="checkbox"/>	<input type="checkbox"/>	<input type="checkbox"/>	<input type="checkbox"/>	<input type="checkbox"/>	<input type="checkbox"/>	<input type="checkbox"/>	<input type="checkbox"/>	<input type="checkbox"/>	<input type="checkbox"/>	<input type="checkbox"/>	<input type="checkbox"/>	<input type="checkbox"/>
4 analogue outputs 4-20 mA	AO20	<input type="checkbox"/>	<input type="checkbox"/>	<input type="checkbox"/>	<input type="checkbox"/>	<input type="checkbox"/>	<input type="checkbox"/>	<input type="checkbox"/>	<input type="checkbox"/>	<input type="checkbox"/>	<input type="checkbox"/>	<input type="checkbox"/>	<input type="checkbox"/>	<input type="checkbox"/>	<input type="checkbox"/>
6 temperature inputs PT100	PT1	<input type="checkbox"/>	<input type="checkbox"/>	<input type="checkbox"/>	<input type="checkbox"/>	<input type="checkbox"/>	<input type="checkbox"/>	<input type="checkbox"/>	<input type="checkbox"/>	<input type="checkbox"/>	<input type="checkbox"/>	<input type="checkbox"/>	<input type="checkbox"/>	<input type="checkbox"/>	<input type="checkbox"/>
6 temperature inputs PT1000	PT10	<input type="checkbox"/>	<input type="checkbox"/>	<input type="checkbox"/>	<input type="checkbox"/>	<input type="checkbox"/>	<input type="checkbox"/>	<input type="checkbox"/>	<input type="checkbox"/>	<input type="checkbox"/>	<input type="checkbox"/>	<input type="checkbox"/>	<input type="checkbox"/>	<input type="checkbox"/>	<input type="checkbox"/>
* universal card for voltages between 24-48 V AC/DC		J6				J10				J14					

additional requirements:

## STEP 3

Your code:

e <sup>2</sup> TANGO	①	②	③	④	⑤	⑥	⑦	⑧	⑨	⑩	⑪	⑫	
A	B	C	D	E	F	G	H	I	J	K	L	M	N

# INSTRUCTIONS FOR FILLING IN THE FORM

## STEP 1

The presented table includes basic technical parameters of the e<sup>2</sup>TANGO-2000 protections. Only 1 item should be selected from each item numbered from 1 to 10. If "other" is selected, enter the ordered value in the corresponding field in STEP 3.

Explanation for step 1.

- - recommended basic configuration
- OPTOMM - multi-mode fibre optic
- N1 - surface installation ver. 1
- N3 - surface installation ver. 3

## STEP 2

The presented table includes a list of available expansion cards and possible places for their installation in the e<sup>2</sup>TANGO-2000 HV protection central unit. No tick box  means that the given card cannot be installed in a given place. Select the cards to be ordered from the list and mark with the "X" slot in which they are to be installed. The cards' distribution should start with the A slot. The unit capacities are marked with a background colour in the table, respectively.

Explanation for step 2.

- - recommended basic configuration
- maximum 4 cards 8OUT
- maximum 1 AI10 card or 1 AI20 card
- maximum 1 AO10 card or 1 AO20 card
- maximum 1 PT1 card or 1 PT10 card

Describe additional requirements in the designated area.

View of the central unit with a selection of the slot arrangement for expansion cards

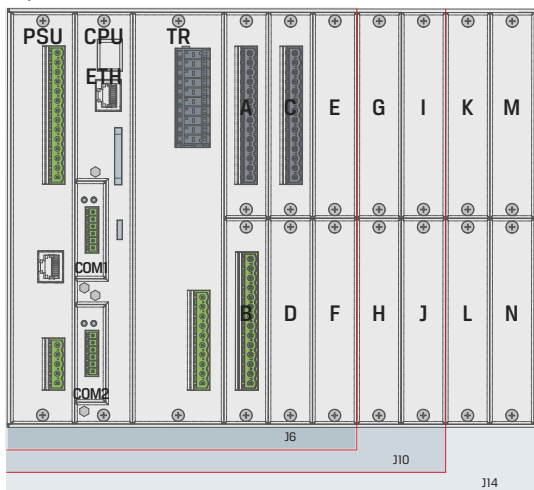

## STEP 3

The above-selected parameters of the e<sup>2</sup>TANGO bay controller should be completed in appropriate fields. The e<sup>2</sup>TANGO code created in such a way together with other requirements or a scanned page of the form should be sent with the order to: [export@elektrometal-energetyka.pl](mailto:export@elektrometal-energetyka.pl)

Example of the e<sup>2</sup>TANGO-2000 HV protection:

① e <sup>2</sup> TANGO-2000-STP	⑨ 8 m cable
② J10 central unit	⑩ protection class IP 4X IEC 61850
③ TRS measuring card	⑪ communication (electric)
④ rated current of the measuring card 5 A	⑫ EN
⑤ universal binary inputs voltage	A slot A: card 8IN
⑥ OPTOMM	B slot B: card 8OUT
⑦ RS485	C slot C: card 12IN
⑧ mixed installation	

Example of correct code completion:

e <sup>2</sup> TANGO	2000-STP	J10	TRS	5A	UNI	OPTOMM	RS485	M	8	IP4X	E	EN
8IN	8OUT	12IN										

**ELEKTROMETAL ENERGETYKA SA**

67 Działkowa Street

02-234 Warsaw

tel. (+48) 22 350 75 50

fax (+48) 22 350 75 51

[eaz@elektrometal-energetyka.pl](mailto:eaz@elektrometal-energetyka.pl)

[www.elektrometal-energetyka.pl](http://www.elektrometal-energetyka.pl)