

Elektrometal Energetyka SA



HV protection unit e²TANGO-2000-ARN[®] (Voltage regulator)



Elektrometal Energetyka SA **FR1 TRANSFORMATOR 110/15 KV TR1**

eTANGO 3500 Elektrometal Energetyka SA

FR100 2000 IBA1 Bank 1 03.04.16 18.38.3000

AUTOMATYCZNA REGULACJA NAPIĘCIA

110kV 15kV

AB11 - Nast. Odcił 1

Zacznik - 1P

FR100
AUTOMATYCZNA
REG. NAP.
TRANSFORMATORA

eTANGO 3500 Elektrometal Energetyka SA

FR100 2000 IBA1 Bank 1 13.57.36 15.55.3000

110kV 15kV

500kV 500kV

1P

Temp 2.0s. na Ocił

I1 = 3.76A U12 = 116kV
I2 = 3.23A U23 = 116kV
I3 = 3.02A U31 = 116kV

P = -427.90W Q = -23.70var

FR100
K01
STERCZANIE
FAZY

eTANGO 2000 Elektrometal Energetyka SA

FR100 2000 IBA1 Bank 1 03.04.16 15.55.3000

110kV 15kV

110kV 15kV

500kV 500kV

1P

FR100
K02
ZABIEGACZKA
STERCZANIE
TRANSFORMATORA

eTANGO 200 Elektrometal Energetyka SA

TR 00R

I1 = 3.76A
I2 = 3.23A
I3 = 3.02A

FR100
K01
AUTOMATYCZNE
ZABIEGACZKOWE
NADPIRANIE

WE CREATE IDEAS WITH POWER!

The family of the e²TANGO-2000-series HV protection relays has been developed by our R&D team consisting of engineers with extensive practical knowledge and many years of experience in the industry. The idea behind creating a high-voltage protection automation platform was to provide clients with operational surety of hardware, software and algorithms.

The e²TANGO-50, e²TANGO-100, e²TANGO-200, e²TANGO-400, e²TANGO-600, e²TANGO-800, e²TANGO-1000, e²TANGO-1200 protection relays and bay controllers for MV have been installed in thousands of facilities across the country and Europe. The hardware platform is based on the same central unit as for the e²TANGO series, of course, with the same configuration of processors, memory cards, inputs/outputs, etc. This makes us absolutely convinced that a few years of trouble-free operation of the e²TANGO series hardware gives security for applications in sensitive areas of HV stations and switchgears.

The e²TANGO-2000 software was developed on the basis of proven versions for MV controllers, while the algorithms of protections operation were developed in cooperation with the Institute of Power Engineering in Warsaw. Thanks to this, the user can be sure that the applied solutions have been tested over the last few decades and work reliably in many HV facilities in Poland and Europe.

The safety of the HV protection relays' users and operated power facilities was our priority when creating e²TANGO-2000. Therefore, in addition to the certainty of the hardware and software side, we have performed a full type testing completed with a certificate confirming the workmanship quality of the HV protection relays series.



Dariusz Rybak
Chief Designer of the e²TANGO series
Elektrometal Energetyka SA



APPLICATION OF HV PROTECTIONS

The e²TANGO HV protections portfolio constitutes a wide range of protection automation devices, including overcurrent and earth-fault protections, differential protection of transformer, voltage regulator, and line residual current protection. The e²TANGO-2000 protection units can be used in bays with the various intended use and operating nature, e.g., in HV line bays or HV/MV transformer bays, but also in facilities of distribution, industrial and other power engineering, which have high-voltage (HV) stations.

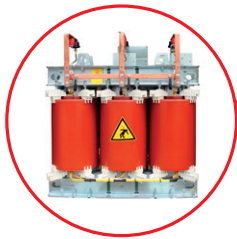

automatic voltage regulation

- load current compensation
- quick taps replacement



HV recipients



HV station

HV/MV TRANSFORMER BAY DIAGRAM

A diagram of exemplary HV transformer bay with marked places for installing the e²TANGO-2000 and e²TANGO-200 type protection automation is presented below.

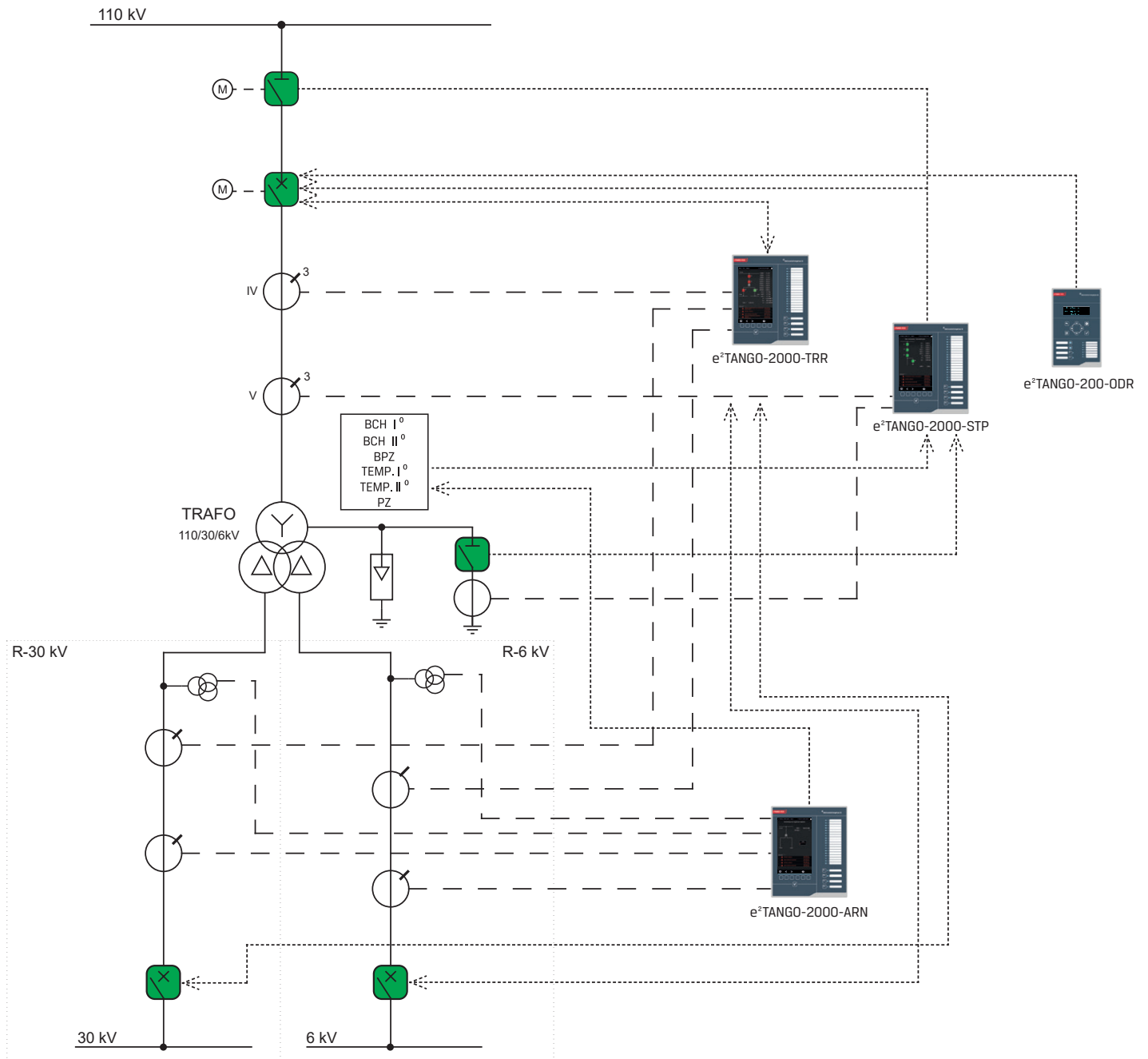

A comprehensive solution for the HV transformer bay, which includes all protection automation elements based on the e²TANGO platform, is demonstrated. The transformer differential protection (TRR), bay controller (STP), and voltage regulator (ARN) are constructed on the e²TANGO-2000 base; while autonomous protections, e.g., -ODR, are designed based on the e²TANGO-200 protection with capacity accumulator.

ADVANTAGES OF HV PROTECTIONS



spinning reserve

restoring the bay to work after a failure within several minutes, possibility to restore all bay data, e.g.: settings, logic, events



remote service access

remote and local readout of diagnostic data with the possibility of sending it to the manufacturer's service



tested algorithms

protection algorithms developed in cooperation with the Institute of Power Engineering



verified hardware base

basing on proven hardware and software of the e²TANGO MV controllers

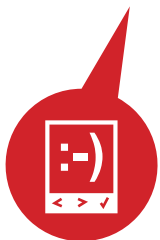
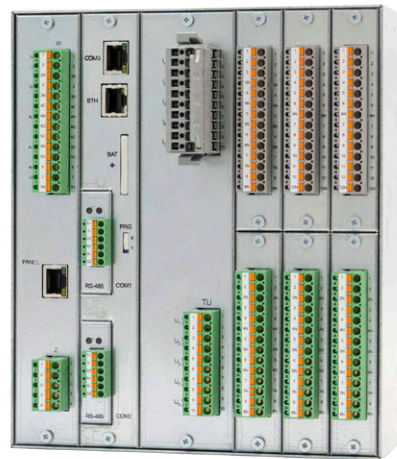

intuitive interface

legible menu layout, illustrative captions and markings

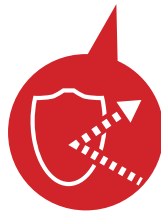

high interference resistance

up to 100% higher than required by the standard

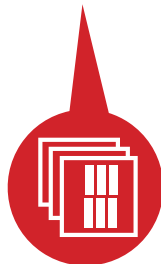

wide range of hardware configurations

6-, 10-, 14-slot units are available with surface, flush, and mixed installation option

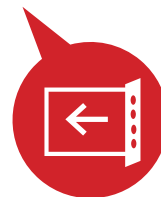

expansion cards diversity

modular design based on expansion and communication cards, up to 168 inputs and up to 39 outputs



review of the diagram and logic current status

logic and synoptic diagrams



complete operating manual

quick access to the associated chapters of the technical documentation



legible menu

pictorialness of captions and markings

Parameter	Description	Range
TRP	TRP signalis	Bay 11 SZR Subset 1
WRN	WRN signalis	Bay 11 SZR Subset 1
AL	Autoclearing	Autoclearing



graphic presentation of parameters

phasors, harmonics content



fully configurable graphic interface

up to five configurable screens, rich widget database



can be operated without the manual

quick-access help

Intuitive and easy-to-use e²TANGO HV protection units are equipped with a fully configurable, clear screen and extensive configuration, registration, and measurement functions. The legibility of indications and signalling, easy access to documentation and instructions, easy verification of logic operation, and graphical verification of protections' characteristics or remote service access definitely improve daily work with the device.

DESIGN

The e²TANGO-series HV protections consist of two elements: operator panel and central unit. The central unit is made based on expansion cards and comes in three housing versions: J6 (6 cards), J10 (10 cards) and J14 (14 cards) - depending on the complexity of the switchboard bay layout and user's needs. The e²TANGO-2000 operator panel has a 7-inch, high-resolution colour screen.



INTERFACE AND OPERATION	
Display	7"
Display resolution	800×480 px
Colour display	•
Touch screen	o
Context buttons (quantity)	-
Control buttons (v)	o
Programmable function keys with LEDs	4
LED	18
Virtual LED (on LCD)	o
Virtual function keys (on LCD)	o
Replaceable labels	•
DESIGN AND EQUIPMENT	
Panel dimensions (external - H×W×D)	252×215×41,5
Mounting opening dimensions in flush version	228×191
External central unit	•
J6 unit	o
• 6 slots	
• dimensions: 222×187×103 (H×W×D)	
J10 unit	•
• 10 slots	
• dimensions: 222×234×103 (H×W×D)	
J14 unit	o
• 14 slots	
• dimensions: 222×281×103 (H×W×D)	

STANDARD EQUIPMENT**	
number of binary inputs (max*)	28 (168)
number of binary outputs (max*)	23 (39)
Max. number of switches	12
Analogue inputs 0-10 V (max)**	0 (4)
Analogue outputs 4-20 mA (max)**	0 (4)
Analogue output 0-10 V (max)**	0 (4)
Temperature inputs (max)**	0 (12)
Current measuring card for differential protection	0 (2 dla TRR)
OTHER	
Widgets	•
Number of configurable screens	5
Logic preview on display	•

•/o - standard/option

* - for the largest unit available and with all slots occupied with one type of card

** - the required number of expansion cards

EXPANSION CARDS

PRIMARY CARDS

- power supply or power supply with reinforced contacts (connection ability up to 10 A DC)
- processor



MEASURING CARDS

- standard (5I+4U)
- synchrocheck (4I+5U)

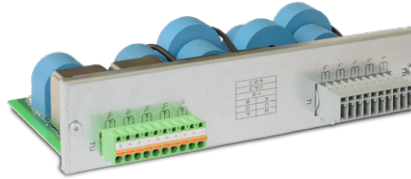

FUNCTION CARDS

- 8 binary inputs
- 12 binary inputs
- 8 relay outputs
- 4 relay outputs with reinforced contacts (connection ability up to 10 A DC)



ANALOGUE CARDS

- 4 analogue inputs 0-10 V
- 4 analogue inputs 4-20 mA
- 4 analogue outputs 0-10 V
- 4 analogue outputs 4-20 mA



TEMPERATURE CARDS

- 6 temperature inputs PT100
- 6 temperature inputs PT1000



PORTS AND COMMUNICATION PROTOCOLS

- Ethernet
- Single-mode optical fibre - OPTOSM
- Multi-mode optical fibre - OPTOMM
- Plastic optical fibre - OPTOP
- RS485
- CANbus 2x
- USB 2.0
- WiFi*

* after agreement with the manufacturer

- Modbus RTU/TCP
- IEC 60870-5-103
- DNP 3.0
- Profibus
- CANbus/PPM 2
- IEC 61850



RECORDERS

- event recorder, 1000 events
- interference recorder up to 160 s sampling frequency 1.6 - 3.2 kHz
- criterion recorder for TRR 250 ms
- recording of instantaneous values, TrueRMS
- phasor

e²TANGO-2000



J6



J10

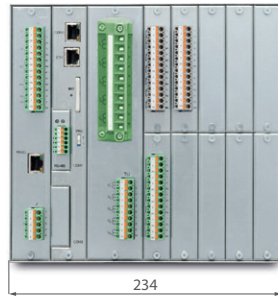

J14

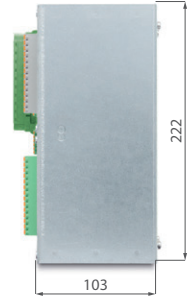
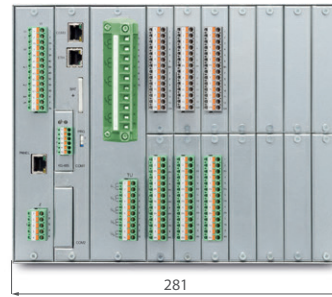

 INSTALLATION METHODS

flush installation

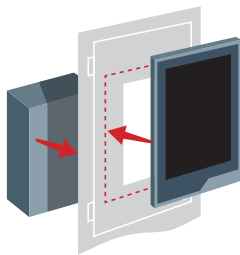

surface installation

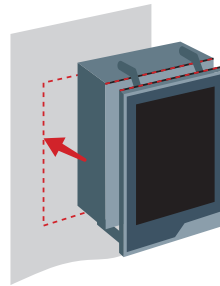

version 1

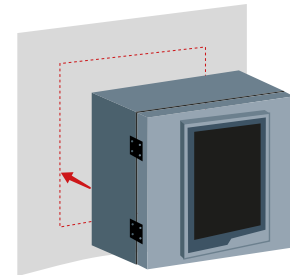

version 3

mixed installation

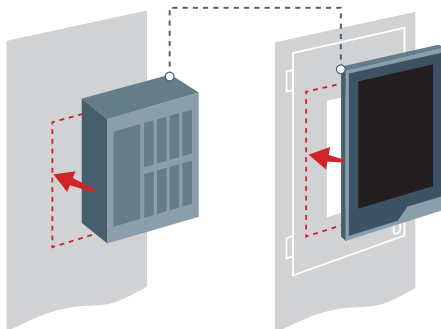

installation in a rack cabinet

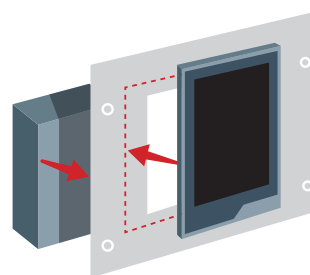

TECHNICAL PARAMETERS

POWER SUPPLY WITH AUXILIARY VOLTAGE	
DC voltage AC voltage Option	110 V, 220 V (80-300 V DC) 230 V (88-265 V AC) 24-48 V (19-58 V AC/DC)
Max. power consumption (panel and unit)	30 W (VA)
CURRENT MEASUREMENT CIRCUITS	
Rated current	1 A or 5 A
Rated frequency	50 Hz
Phase current measurement range	0.05-150 A
VOLTAGE MEASUREMENT CIRCUITS	
Rated voltage	57,7/100 V
Rated frequency	50 Hz
Voltage measurement range	3-120 V
Measurement accuracy I1, I2 (0,1-150 A) U1, U2 (5-120 V)	1% 1%
PARAMETERS OF BINARY OUTPUTS	
Voltage on open contacts	250 V AC, 440 V DC
Permanent load	5.0 A
Circuit deactivation at 220 V DC (L/R = 40 ms)	0.1 A
Circuit deactivation at 220 V AC (cos ϕ = 0.4)	2.0 A
PARAMETERS OF BINARY INPUTS	
Rated voltage Optional Other on request	110/230 V AC/DC 24-48 V (19-58 V AC/DC)
Maximum current consumption at 220 V DC; 230 V AC	2 mA; 15 mA
ENVIRONMENTAL CONDITIONS	
Operating temperature	-10°C to +55°C
Storage temperature	-25°C to +70°C
Relative humidity	5% to 95%, without water vapour condensation
Vibrations and mechanical impacts	Class 1 acc. to IEC 60255-21
Electromagnetic interferences	Class B acc. to IEC 60255-26
SAFETY	
Insulation electric strength	2 kV/50 Hz/60 s acc. to IEC 60255-27
DIMENSIONS	
Weight (central unit/operator panel)	5 kg/1 kg
Central unit dimensions (WxDxH mm)	222x103x187/234/281
Central unit protection class	IP 3X/IP 4X (option)
Panel protection class (front plate side)	IP 4X/IP 54 (option)

e²TANGO-STUDIO SOFTWARE

The e²TANGO-Studio is an engineering program dedicated to the e²TANGO bay controller and, at the same time, a configuration tool for the panel. The programme has been developed and equipped with a rich set of functionalities, which, combined with a clear visual configuration of widgets, becomes excellent support in everyday work, enabling the creation of projects for many devices, panels, switchboards, or stations.



advanced designing
possibility of preparing the devices' configuration for the whole switchboard on the PC and its distribution using USB

user elements
defining customised graphic elements of the synoptic diagram



quick configuration assistant
facilitating the first use of the programme and support during regular work



on-line preview
live preview of I/O statuses, measurements; real preview of the image displayed on the LCD screen

displaying compliance
preview of the actual view of the panel screen



possible further expansion
using plug-ins



visual characteristics' shaping
graphical and standard configuration of protections' settings

simple verification of settings and selectivity
presentation of the whole overcurrent protections' family presentation on one chart

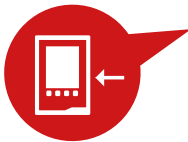

full statuses' view
access to all internal statuses of the device and protections

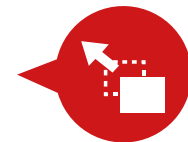

instant user screen designing
placing elements supported by drag&drop method

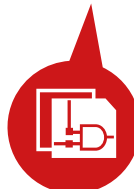
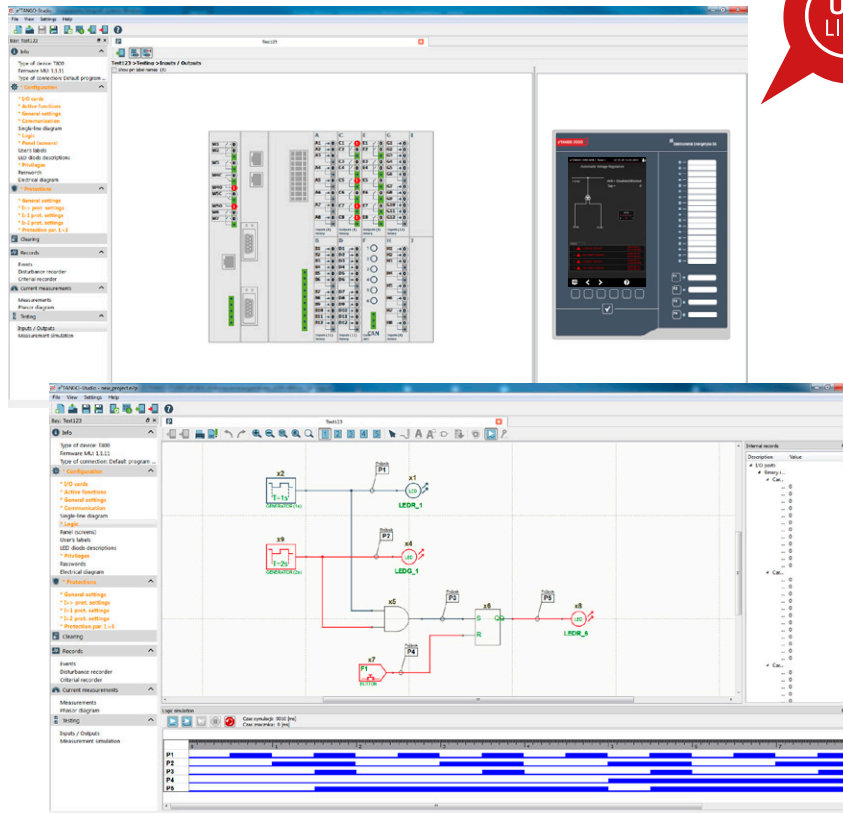

logic simulator
possibility of full simulation of logic without connecting to the device

logic legibility
possibility of dividing the logic into blocks and sheets

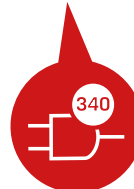

operation of extended logical dependencies
up to 340 logical gates/functions

ADVANCED LOGIC EDITOR AND SIMULATOR

The e²TANGO-Studio features an advanced and extended logic editor that allows for simulating the logic circuit, also visible from the panel, without connecting the device. It allows previewing logical statuses while working with the device, which facilitates project preparation, as well as commissioning and servicing of switching stations. It gives the possibility to design non-standard logics dedicated to the requirements of the client's infrastructure.

STANDARISATION

PN-EN 60255-1	Measuring relays and protection equipment. Part 1: Common requirements
PN-EN 60255-26	Measuring relays and protection equipment. Part 26: Electromagnetic compatibility requirements
PN-EN 60255-27	Measuring relays and protection equipment. Part 27: Product safety requirements

CERTIFICATES AND AWARDS



IEEn Certificate of Compliance
No. 005/2019

for the e²TANGO-2000 HV
protection units



Gold medal
ENERGETAB 2015 trade fair



Minister of Energy Cup
ENERGETAB 2018 trade fair



Mazovian Quality Award

ELEKTROMETAL ENERGETYKA SA QUALITY

Integrated Management System is implemented in the company, based on the following standards:

- PN-EN ISO 9001 Quality Management Systems
- PN-EN ISO 14001 Environmental Management Systems
- PN-EN ISO 45001 Occupational Health and Safety Management Systems

ORDER FORM

To order the e²TANGO-2000 protections, please fill in this part of the form according to the INSTRUCTIONS FOR FILLING IN THE FORM on the next page.

STEP 1

① panel version	<input checked="" type="checkbox"/> 2000-ARN					
② central unit version	<input checked="" type="checkbox"/> J6	<input type="checkbox"/> J10	<input type="checkbox"/> J14	<input type="checkbox"/> J6H ¹⁾	<input type="checkbox"/> J10H ¹⁾	<input type="checkbox"/> J14H ¹⁾
③ TR measuring card version	<input type="checkbox"/> TR (standard, 5I+4U)	<input checked="" type="checkbox"/> TRS (4I+5U)				
④ measuring card parameters	<input checked="" type="checkbox"/> 5 A	<input type="checkbox"/> 1 A				
⑤ power supply voltage	<input checked="" type="checkbox"/> UNI (110/230 V AC/DC)	<input type="checkbox"/> 24V (24/48 V AC/DC)	<input type="checkbox"/> others			
Ethernet communication port (standard on each central unit)						
⑥ COM1	<input checked="" type="checkbox"/> x-none	<input type="checkbox"/> RS485	<input type="checkbox"/> CANx2	<input type="checkbox"/> OPTOMM	<input type="checkbox"/> OPTOP	<input type="checkbox"/> Profibus <input type="checkbox"/> others
⑦ COM2	<input checked="" type="checkbox"/> x-none	<input type="checkbox"/> RS485	<input type="checkbox"/> CANx2	<input type="checkbox"/> OPTOMM	<input type="checkbox"/> OPTOP	<input type="checkbox"/> Profibus <input type="checkbox"/> others
⑧ installation method	<input checked="" type="checkbox"/> Z-flush	<input type="checkbox"/> N1 - surface ver. 1	<input type="checkbox"/> N3 - surface ver. 3	<input type="checkbox"/> M - Mixed	<input type="checkbox"/> ZR - flush in rack cabinet	
⑨ panel-unit cable length	<input checked="" type="checkbox"/> S-1 m	<input type="checkbox"/> L-2 m	<input type="checkbox"/> other			
⑩ IP protection class	<input checked="" type="checkbox"/> IP 4X	<input type="checkbox"/> IP 54 ²⁾				
⑪ communication IEC 61850	<input checked="" type="checkbox"/> EX-none	<input type="checkbox"/> O-ETH fibre optic	<input type="checkbox"/> O2-ETH fibre optic with PRP	<input type="checkbox"/> O2G-O2+GOOSE	<input type="checkbox"/> E2-electric	
	<input type="checkbox"/> E-ETH electric	<input type="checkbox"/> EG-ETH electric+GOOSE	<input type="checkbox"/> OG-ETH fibre optic +GOOSE	<input type="checkbox"/> E2G-electric +GOOSE		
⑫ language version	<input type="checkbox"/> PL	<input checked="" type="checkbox"/> EN	<input type="checkbox"/> other - in agreement with manufacturer			

1) reinforced W1, W2, W3 outputs

2) protection class IP54 only available in version with flush and mixed installation

STEP 2

Card name	Kod	Slot												
		A	B	C	D	E	F	G	H	I	J	K	L	M
CPU processor card	-	standard in every device												
PSU power supply card - 7 relay outputs	-	standard in every device												
Ethernet communication port	-	standard in every device												
8 binary inputs	8IN	<input checked="" type="checkbox"/>	<input type="checkbox"/>	<input type="checkbox"/>	<input type="checkbox"/>	<input type="checkbox"/>	<input type="checkbox"/>	<input type="checkbox"/>	<input type="checkbox"/>	<input type="checkbox"/>	<input type="checkbox"/>	<input type="checkbox"/>	<input type="checkbox"/>	<input type="checkbox"/>
12 binary inputs	12IN	<input type="checkbox"/>	<input type="checkbox"/>	<input checked="" type="checkbox"/>	<input type="checkbox"/>	<input type="checkbox"/>	<input type="checkbox"/>	<input type="checkbox"/>	<input type="checkbox"/>	<input type="checkbox"/>	<input type="checkbox"/>	<input type="checkbox"/>	<input type="checkbox"/>	<input type="checkbox"/>
8 binary inputs 24-48 V*	8IN24	<input type="checkbox"/>	<input type="checkbox"/>	<input type="checkbox"/>	<input type="checkbox"/>	<input type="checkbox"/>	<input type="checkbox"/>	<input type="checkbox"/>	<input type="checkbox"/>	<input type="checkbox"/>	<input type="checkbox"/>	<input type="checkbox"/>	<input type="checkbox"/>	<input type="checkbox"/>
12 binary inputs 24-48 V*	12IN24	<input type="checkbox"/>	<input type="checkbox"/>	<input type="checkbox"/>	<input type="checkbox"/>	<input type="checkbox"/>	<input type="checkbox"/>	<input type="checkbox"/>	<input type="checkbox"/>	<input type="checkbox"/>	<input type="checkbox"/>	<input type="checkbox"/>	<input type="checkbox"/>	<input type="checkbox"/>
8 relay outputs	8OUT	<input type="checkbox"/>	<input checked="" type="checkbox"/>	<input type="checkbox"/>	<input type="checkbox"/>	<input type="checkbox"/>	<input type="checkbox"/>	<input type="checkbox"/>	<input type="checkbox"/>	<input type="checkbox"/>	<input type="checkbox"/>	<input type="checkbox"/>	<input type="checkbox"/>	<input type="checkbox"/>
4 relay outputs, reinforced	4OUTH	<input type="checkbox"/>	<input type="checkbox"/>	<input type="checkbox"/>	<input type="checkbox"/>	<input type="checkbox"/>	<input type="checkbox"/>	<input type="checkbox"/>	<input type="checkbox"/>	<input type="checkbox"/>	<input type="checkbox"/>	<input type="checkbox"/>	<input type="checkbox"/>	<input type="checkbox"/>
4 analogue inputs 0-10 V	AI10	<input type="checkbox"/>	<input type="checkbox"/>	<input type="checkbox"/>	<input type="checkbox"/>	<input type="checkbox"/>	<input type="checkbox"/>	<input type="checkbox"/>	<input type="checkbox"/>	<input type="checkbox"/>	<input type="checkbox"/>	<input type="checkbox"/>	<input type="checkbox"/>	<input type="checkbox"/>
4 analogue inputs 4-20 mA	AI20	<input type="checkbox"/>	<input type="checkbox"/>	<input type="checkbox"/>	<input type="checkbox"/>	<input type="checkbox"/>	<input type="checkbox"/>	<input type="checkbox"/>	<input type="checkbox"/>	<input type="checkbox"/>	<input type="checkbox"/>	<input type="checkbox"/>	<input type="checkbox"/>	<input type="checkbox"/>
4 analogue outputs 0-10 V	AO10	<input type="checkbox"/>	<input type="checkbox"/>	<input type="checkbox"/>	<input type="checkbox"/>	<input type="checkbox"/>	<input type="checkbox"/>	<input type="checkbox"/>	<input type="checkbox"/>	<input type="checkbox"/>	<input type="checkbox"/>	<input type="checkbox"/>	<input type="checkbox"/>	<input type="checkbox"/>
4 analogue outputs 4-20 mA	AO20	<input type="checkbox"/>	<input type="checkbox"/>	<input type="checkbox"/>	<input type="checkbox"/>	<input type="checkbox"/>	<input type="checkbox"/>	<input type="checkbox"/>	<input type="checkbox"/>	<input type="checkbox"/>	<input type="checkbox"/>	<input type="checkbox"/>	<input type="checkbox"/>	<input type="checkbox"/>
6 temperature inputs PT100	PT1	<input type="checkbox"/>	<input type="checkbox"/>	<input type="checkbox"/>	<input type="checkbox"/>	<input type="checkbox"/>	<input type="checkbox"/>	<input type="checkbox"/>	<input type="checkbox"/>	<input type="checkbox"/>	<input type="checkbox"/>	<input type="checkbox"/>	<input type="checkbox"/>	<input type="checkbox"/>
6 temperature inputs PT1000	PT10	<input type="checkbox"/>	<input type="checkbox"/>	<input type="checkbox"/>	<input type="checkbox"/>	<input type="checkbox"/>	<input type="checkbox"/>	<input type="checkbox"/>	<input type="checkbox"/>	<input type="checkbox"/>	<input type="checkbox"/>	<input type="checkbox"/>	<input type="checkbox"/>	<input type="checkbox"/>
		J6						J10				J14		

* universal card for voltages between 24-48 V AC/DC

additional requirements:

STEP 3

Your code:

e²TANGO
①
②
③
④
⑤
⑥
⑦
⑧
⑨
⑩
⑪
⑫

A
B
C
D
E
F
G
H
I
J
K
L
M
N

INSTRUCTIONS FOR FILLING IN THE FORM

STEP 1

The presented table includes basic technical parameters of the e²TANGO-2000 protections. Only 1 item should be selected from each item numbered from 1 to 10. If "other" is selected, enter the ordered value in the corresponding field in STEP 3.

Explanation for step 1.

-  - recommended basic configuration
- OPTOMM - multi-mode fibre optic
- N1 - surface installation ver. 1
- N3 - surface installation ver. 3

STEP 2

The presented table includes a list of available expansion cards in the e²TANGO-2000 HV protection central unit. No tick box means that the given card cannot be installed in a given place. Select the cards to be ordered from the list and mark with the "X" slot in which they are to be installed. The cards' distribution should start with the A slot. The unit capacities are marked with a background colour in the table, respectively.

Explanation for step 2.

-  - recommended basic configuration
- maximum 4 cards 8OUT
- maximum 1 AI10 card or 1 AI20 card
- maximum 1 AO10 card or 1 AO20 card
- maximum 1 PT1 card or 1 PT10 card

Describe additional requirements in the designated area.

View of the central unit with a selection of the slot arrangement for expansion cards

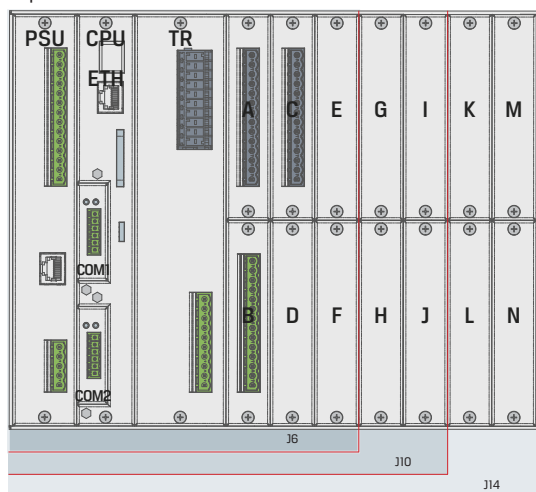

STEP 3

The above-selected parameters of the e²TANGO bay controller should be completed in appropriate fields. The e²TANGO code created in such a way together with other requirements or a scanned page of the form should be sent with the order to: export@elektrometal-energetyka.pl

Example of the e²TANGO-2000 HV protection configuration:

- | | |
|---|-----------------------------------|
| ① e ² TANGO-2000-ARN | ⑨ 8 m cable |
| ② J10 central unit | ⑩ protection class IPX4 IEC 61850 |
| ③ TRS measuring card | ⑪ communication (electric) |
| ④ rated current of the measuring card 5 A | ⑫ EN |
| ⑤ universal binary inputs voltage | A slot A: card 8IN |
| ⑥ OPTOMM | B slot B: card 8OUT |
| ⑦ RS485 | C slot C: card 12IN |
| ⑧ mixed installation | |

Example of correct code completion:

e ² TANGO	2000-ARN	J10	TRS	5A	UNI	OPTOMM	RS485	M	8	IP4X	E	EN
8IN	8OUT	12IN										

ELEKTROMETAL ENERGETYKA SA

67 Działkowa Street

02-8234 Warsaw

tel. (+48) 22 350 75 50

fax (+48) 22 350 75 51

eaz@elektrometal-energetyka.pl

www.elektrometal-energetyka.pl